



CM-250 SERIES ECONOMY 1" PUSH BUTTONS



CM-250/7



CM-250/3H

FEATURES

- 1" RED BUTTON REQUIRES MINIMAL ACTUATION FORCE
- STAINLESS STEEL FACEPLATE AVAILABLE IN NARROW JAMB
- ADA COMPLIANT
- ATTRACTIVE LOW PROFILE DESIGN
- UL/CSA APPROVED SWITCH RATED 15 AMPS @ 30 VDC
- VARIOUS LOGOS, MESSAGES & LANGUAGES
- 3YR. 'CAMDEN TOUGH' WARRANTY WITH '2 FOR 1' REPLACEMENT

DESCRIPTION

Camden CM-250 Series push switches are light-duty, ADA-compliant door controls. Designed for easy installation directly in the door jamb, or use optional surface box. The SPDT switches are UL/CSA approved, and rated 15 Amps. @ 30 VDC.

APPLICATION

Camden 1" push button switches are designed to control electric locks & strikes, magnetic locks, automatic pedestrian & overhead doors.

They may also be used for shunting, bypassing alarms, request to exit, timed functions and many other applications. Camden switches are versatile and can be supplied in various logos and languages to suit any commercial, industrial or residential application.

ARCHITECTS/ENGINEERS SPECIFICATIONS

The switches to be used throughout the site/complex shall be Camden Door Controls CM-250 series push switches.

The switches shall be easy-to-activate, ADA compliant and utilize a 1" red button. Faceplates shall be constructed of 18 gauge stainless steel, and have matching stainless steel mounting screws. Switches shall be rated at a minimum of 15 Amps. @ 30V DC.

ECONOMY 1" PUSH BUTTONS

SPECIFICATIONS

VOLTAG:	12/24 VDC
CURRENT TYPE:	SPDT FORM 'C'
CONTACT RATING:	15 AMPS@30V DCS
SWITCH TYPE:	MOMENTARY
STD. FINISH:	US32 / 32D
DIMENSIONS:	4 1/2" H x 1 5/8" W x 1 11/32" D (114mm x 41mm x 32mm)

ORDERING INFORMATION













All CM-250 Series push switches are complete ready-to-install assemblies. They are supplied with matching stainless steel mounting screws and wire terminals.

MODEL	DESCRIPTION
CM-250	SWITCH WITH STAINLESS STEEL FACEPLATE

OPTIONS

(Add suffix to model above)

FACEPLATE GRAPHIC OPTIONS

 CM-XX/1	 CM-XX/2	 CM-XX/2H	 CM-XX/3	 CM-XX/3H
 CM-XX/3F	 CM-XX/3S	 CM-XX/4	 CM-XX/4H	 CM-XX/4F
 CM-XX/7	 CM-XX/7F	 CM-XX/8	 CM-XXE	

NOTE: all faceplate graphics are in black except wheelchair and, wheelchair + text in blue.

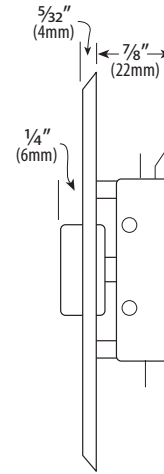

CM-250

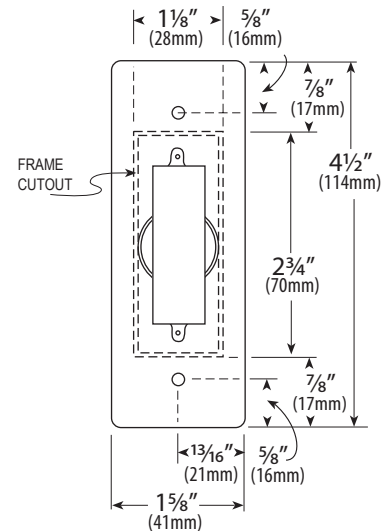

CM-250