



CM-40/41

4 1/2" ROUND ALL-ACTIVE SWITCHES



CM-40/2



CM-40/4



CM-41/2

FEATURES

- LARGE, EASY TO OPERATE SWITCHES
- 4 1/2" ROUND FACEPLATES
- ALL-ACTIVE DESIGN REQUIRES MINIMAL ACTUATION FORCE
- MEETS ADA REQUIREMENTS
- DURABLE STAINLESS STEEL OR SOLID BRASS CONSTRUCTION
- FLUSH MOUNT OR SURFACE MOUNT
- UL/CSA APPROVED SWITCH, RATED 15 AMPS @30V DC
- VARIOUS LOGOS & MESSAGES
- ARCHITECTURAL FINISHES

DESCRIPTION

Camden Door Controls CM-40/41 Series all-active switches are heavy-duty, ADA-compliant door controls. The 4 1/2" round faceplates are stainless steel or solid brass, and the assembly is designed for easy installation.

The CM-40 and CM-41 switches mount to standard 2 x 4 electrical boxes. The SPDT (and optional DPDT) switches are UL/CSA approved, and rated 15 amps @ 30 VDC.

The 4 1/2" square stainless steel backplate on the CM-41 is large enough to dress-up (cover) a poorly installed electrical box. It will also fit perfectly on most 4 1/2" surface boxes.

APPLICATION

Camden all-active switches are designed for areas where an easy-to-activate, high visibility switch is desired. Ideal for high-traffic areas, hospitals, wheelchair access, seniors' residences, etc. They can be surface or flush mounted.

Camden all-active switches are designed to control electric strikes, electromagnetic locks and automatic doors. They may also be used for shunting, bypassing alarms, request to exit, timed functions, and many other applications.

The switches are made for high frequency usage, in both indoor and outdoor environments. Camden switches are versatile, and can be supplied in various configurations and finishes, to suit any commercial, industrial, or residential application.

ARCHITECTS/ENGINEERS SPECIFICATIONS

The switches to be used throughout the complex shall be Camden Door Controls CM-40 or CM-41 series all-active switches.

The switches shall be easy-to-activate, ADA compliant, 4 1/2" round in diameter. Switches shall be all-active, whereby pressing any part of the faceplate will activate the device. Faceplates shall be constructed of 18-gauge stainless steel or solid brass, and have concealed mounting screws for tamper resistance. Switches shall use plastic spacers and rubber dampers for noise reduction. Switches shall be rated at a minimum of 15 amps @ 30V DC.

4 1/2" ROUND ALL-ACTIVE SWITCHES

SPECIFICATIONS

VOLTAGE:	12/24V AC/DC
CONTACT TYPE:	SPDT FORM 'C'
CONTACT RATING:	15A @ 30VDC
SWITCH TYPE:	MOMENTARY
DIMENSIONS:	CM-40: 4 1/2" DIA. x 1 3/4"D (114mm x 44mm) CM-45: 4 1/2"H x 4 1/2"W x 1 3/4"D (114mm x 114mm x 44mm)
STD. FINISH:	US32 / 630

ORDERING INFORMATION











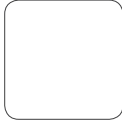



All CM-40/41 series all-active switches are complete ready-to-install assemblies. They are supplied with stainless steel Allen screws and an Allen wrench for mounting.

MODEL	DESCRIPTION
CM-40	4 1/2" ROUND PUSH PLATE SWITCH
CM-41	4 1/2" ROUND PUSH PLATE SWITCH, WITH SQUARE BACK PLATE

OPTIONS

(Add suffix to model above)

FACEPLATE GRAPHIC OPTIONS

				
CM-XX/1	CM-XX/2	CM-XX/2AL	CM-XX/2AR	CM-XX/3
				
CM-XX/3F	CM-XX/4	CM-XX/4AL	CM-XX/4AR	CM-XX/4F
				
CM-XX/8	CM-XX/8B	CM-XX/8D	CM-XX/8F	

ARCHITECTURAL FINISHES:

CM-XXX-AB	ADD 'AB' TO PRODUCT # FOR ANTIQUE BRASS FINISH (BHMA 609, US5)
CM-XXX-SB	ADD 'SB' TO PRODUCT # FOR SATIN BRASS FINISH (BHMA 606, US4)
CM-XXX-OB	ADD 'OB' TO PRODUCT # FOR OIL RUB BRONZE FINISH (BHMA 640, US10B) (NOT COLOR MATCHED) (CANNOT BE CUSTOM LASER ETCHED)
CM-XXX-PB	ADD 'PB' TO PRODUCT # FOR POLISHED BRASS (BHMA 605, US3)

WEATHERPROOF OPTIONS:

CM-XXX-WT	ADD 'WT' TO PRODUCT # FOR BOOT AND WATER TIGHT COATING
-----------	--

CONTACT OPTIONS:

DP	ADD DP TO PRODUCT # TO ORDER DPDT SWITCH INSTEAD OF SPDT SWITCH (USE SPECIAL MOUNTING PLATE/TEMPLATE)
----	---

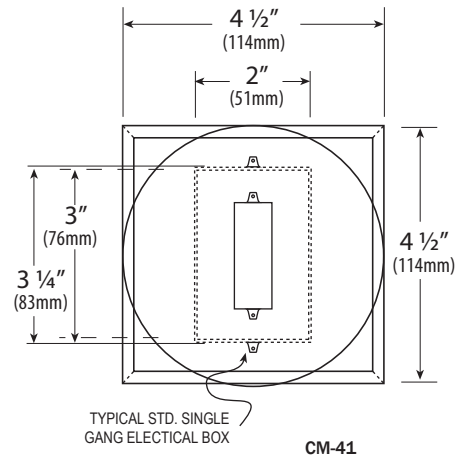
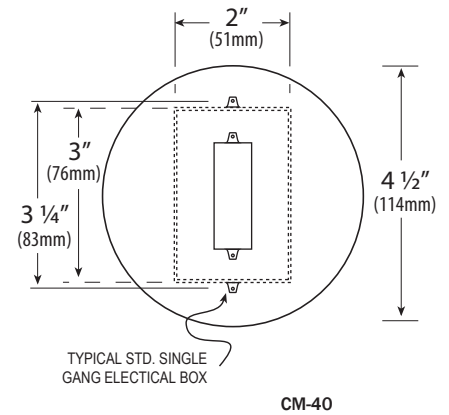

Graphic Colors:

Blue: /2, /2AL, /2AR, /4, /4AL, /4AR; /4F
Black: /3, /3F, /8, /8D; /8F; /8B